

Article number: 6041651300025

Description: Clamping plate for belts HTD 5M 25

Measures

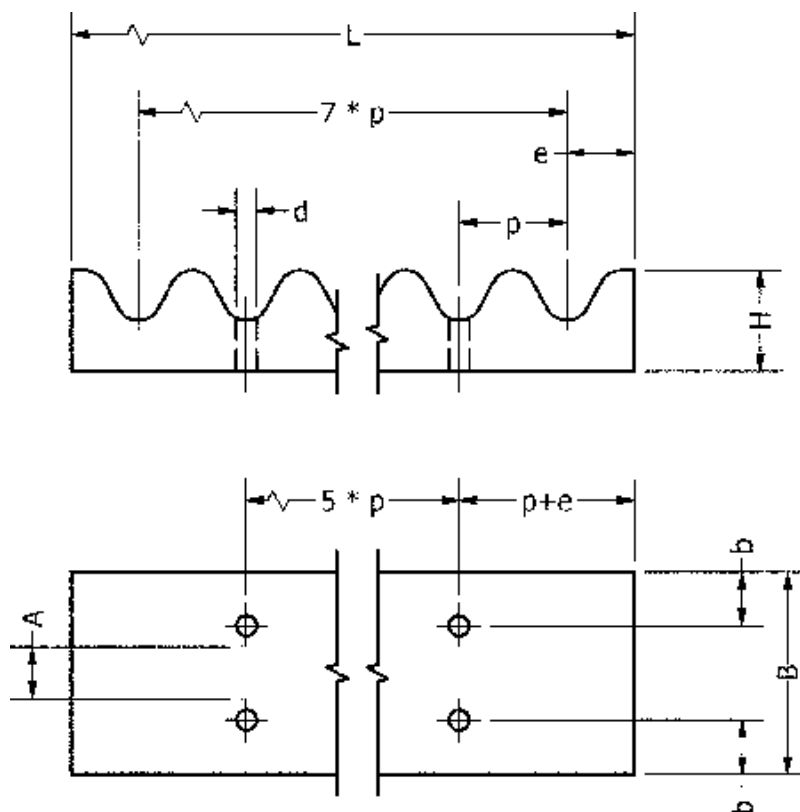

= -	b = 6
= -	B = 44
= -	d = 5.5
= -	e = 3.2
= -	H = 8
= -	L = 41.8
= -	
A = 25	